



Care for People Care for Earth

Koshiro Kudo
Senior Executive Officer
President, Performance Products SBU

AsahiKASEI

November 14, 2019

Blank for your note

Outline

1. Mission of Performance Products SBU
2. Main products and basic strategy
3. New business development
4. Strategy through acquisition of Sage

1. Mission of Performance Products SBU

Make 1+1+1 more than 3

1. Fibers + Performance polymers + Consumables
– Creating synergy –

2. Mobility + Environment & Energy + Life Material
– Growth in priority fields for provision of value –

3. Advantage in materials x Processing x Globalization
– Value chain management –

2. Main products and basic strategy

Main products and overview of basic strategy

Develop advantage in materials globally by reinforcing the value chain, achieve growth in priority fields for provision of value

Materials by priority fields for provision of value

Today's focus

Performance polymers Fibers Consumables

Mobility

S-SBR (tires)
 Synthetic rubber, elastomers (vibration isolation, interior, etc.)
 Engineering plastics (lightweighting)
 Leona nylon 66 filament (airbags, tire cord)
 Lamous artificial suede (seats, interior)
 Sage Automotive Interiors, Inc.
 SunForce m-PPE foamed beads (condensation prevention for EV)

Life Material

Saran Wrap cling film,
 Bemberg cupro fiber, etc.

Environment & Energy

Elastomers,
 Xyron modified polyphenylene ether, etc.

Reinforcing value chain

⇒ Gaining midstream business, strengthening relationships with customers

Example:

Performance polymers
 Polymers ⇒ Compounding ⇒ Sale

Fibers, air bag
 Yarn ⇒ Weaving/sewing ⇒ Sale

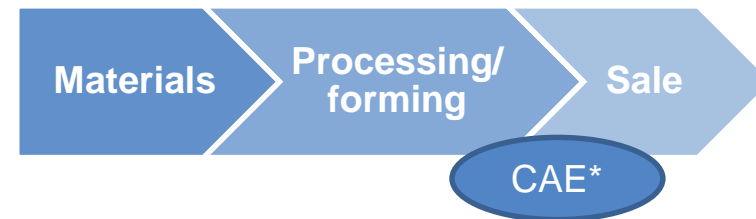

* Computer-aided engineering

Changing needs in Mobility

Requirements for CASE rises with increasing environmental needs

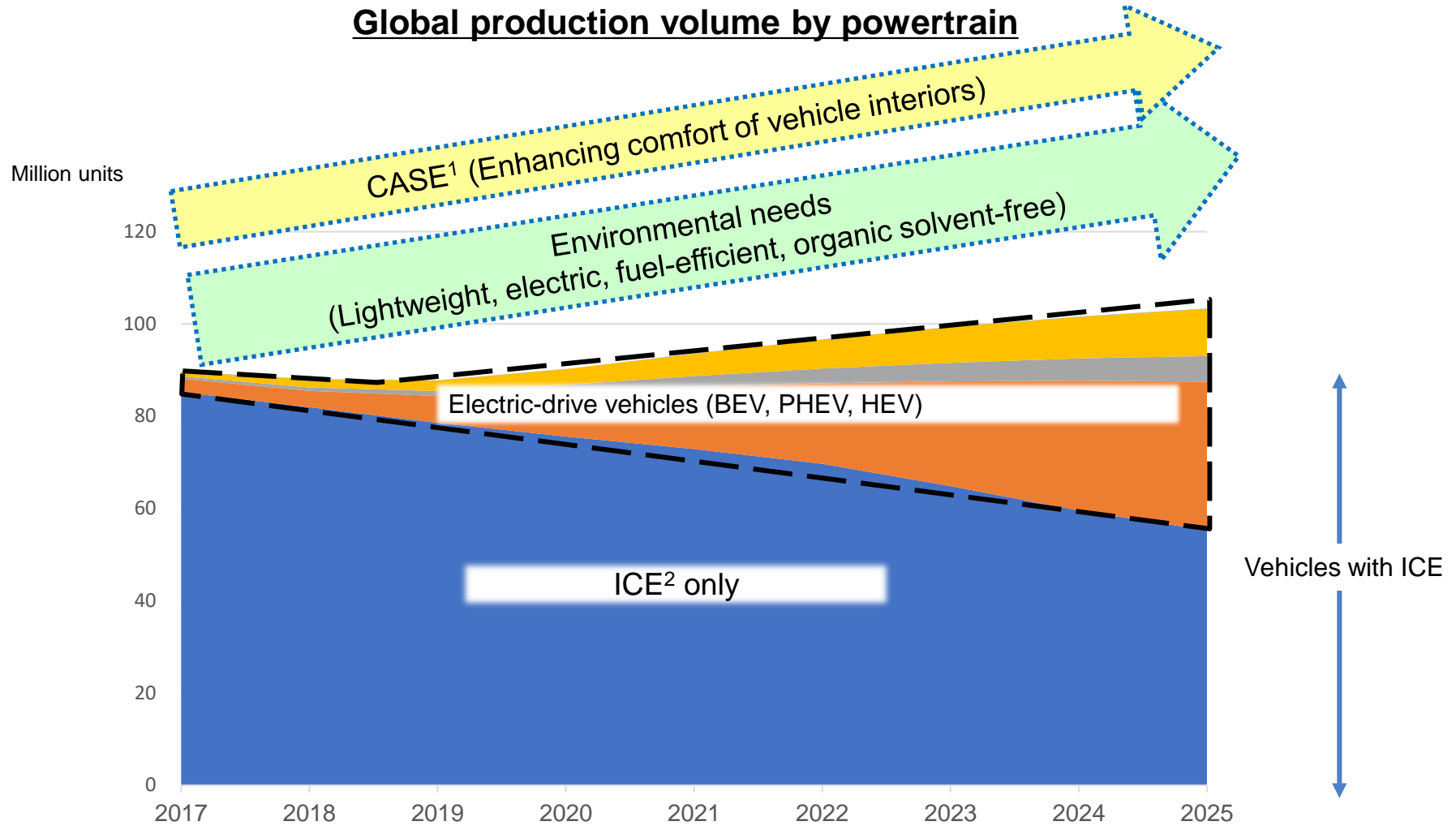

¹ Connected, autonomous, shared/services, electric

² Internal combustion engine

(Source: Adapted from IHS material)

Growth strategy in Mobility

Aim at continuous growth through a strategy to respond to changes in mobility society

Sales growth image in Mobility (Performance Products SBU)

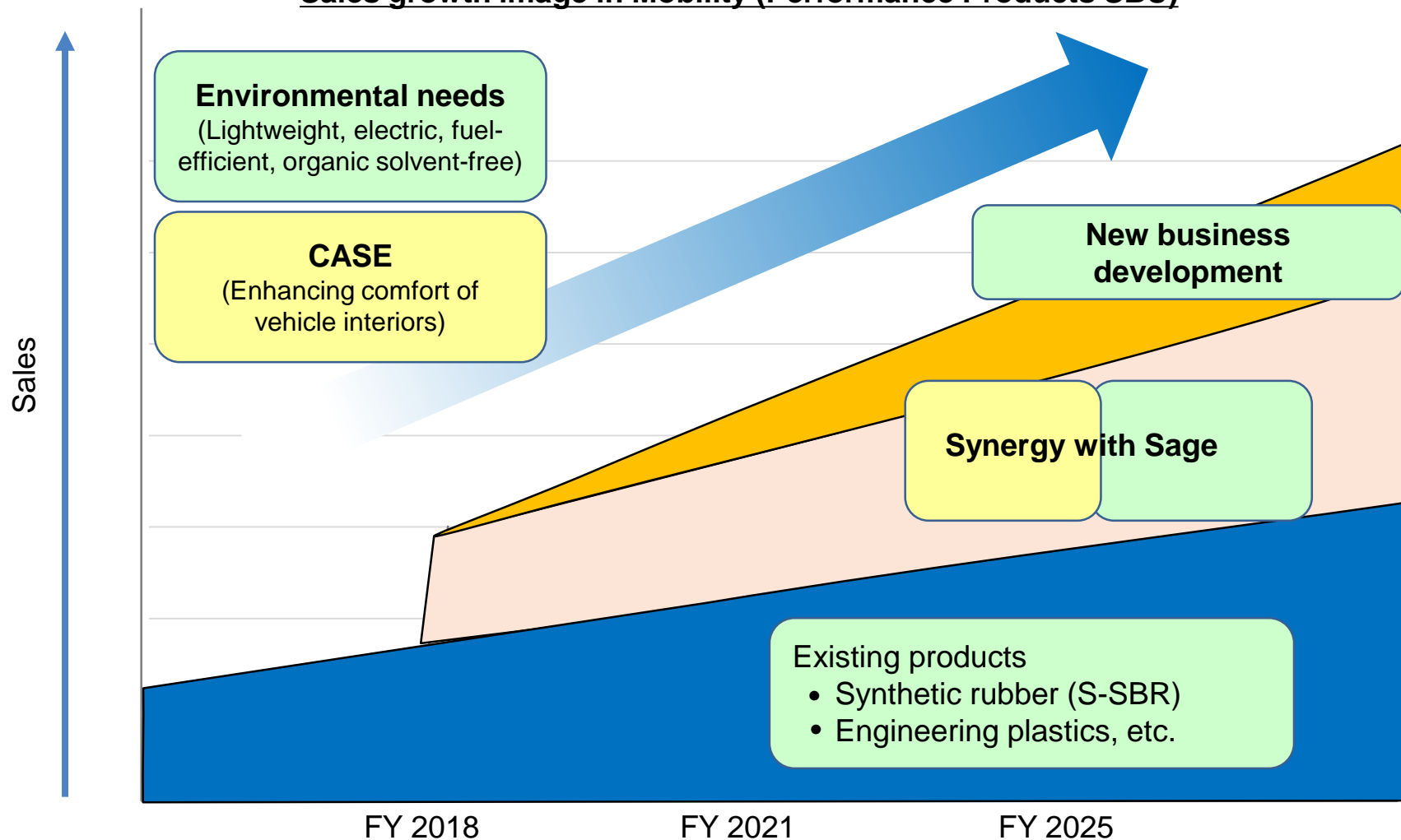

3. New business development (foamed engineering plastic, cellulose nanofiber composite material)

3. New business development

Goals to achieve with foamed engineering plastic

Develop our unique high value-added products to respond to the increasing environmental needs in mobility society, aiming at achieving long-term growth

Our technologies accumulated over time

Polymer processing technology

- Foaming technology



Application development technology

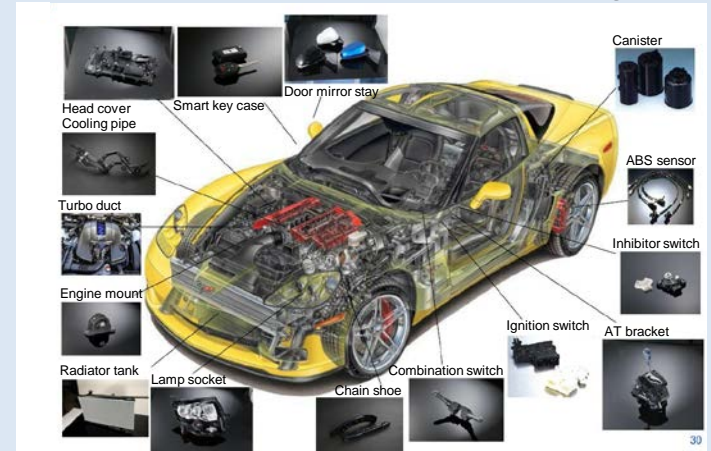

Unique, high value-added products

Modified-PPE foamed beads

Foamed polyamide (PA)

3. New business development

SunForce m-PPE foamed beads

SunForce m-PPE foamed beads, for injection molding

Heat management of a Li-ion battery case for vehicles:
Contributes to higher output in a safer and more efficient way

Heat insulation properties:

Air	0.024
SunForce (at 10x foaming ratio)	0.034
Modified-PPE resin (solid)	0.15
Calcium silicate board heat insulator	0.18
Iron	84
Aluminum	250

↑ High heat insulation properties

Flame retardance: UL94 V-0*

Heat resistance: 100°C

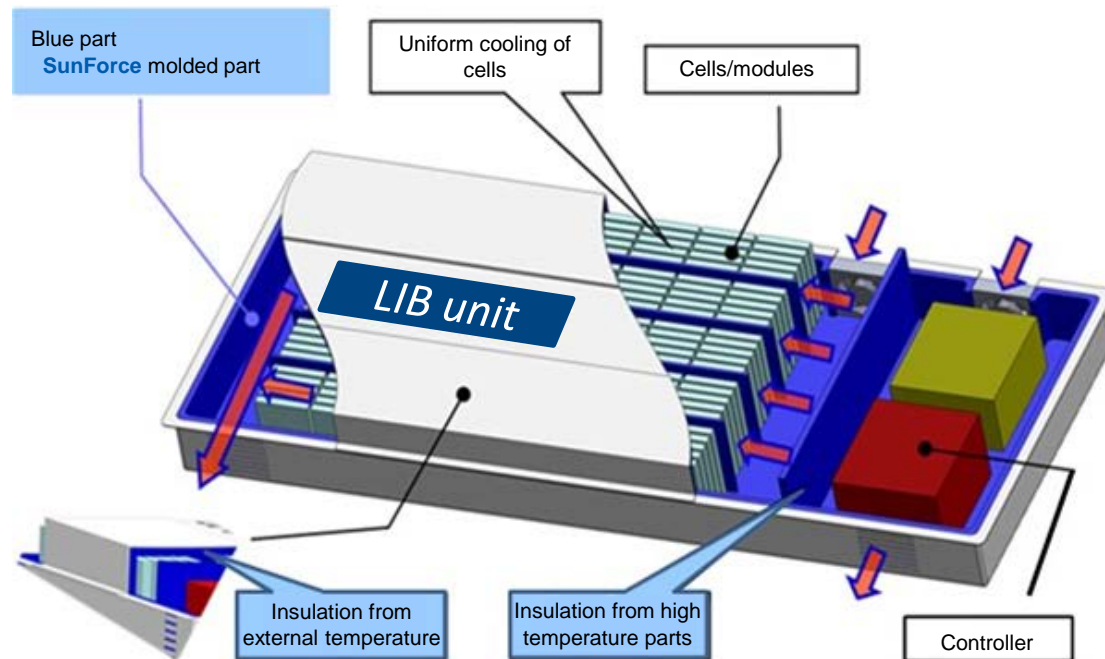

* UL94 is a standard for flammability of plastics used for electric equipment by Underwriters Laboratories in the U.S. V-0 indicates high flame retardance.

3. New business development

Applications and future development of foamed polyamide

1

Sound absorbing parts (particularly in engine room) to comply with restrictions on accelerated running noise (Phase 3 in 2024)

- Engine top cover, splash shield
- Fender liner
- Dash insulator, etc.

2

Exterior parts leveraging lightweight, rigidity, heat resistance, and heat insulation properties

- Roof
- Floor
- Door panel
- Trunk, etc.

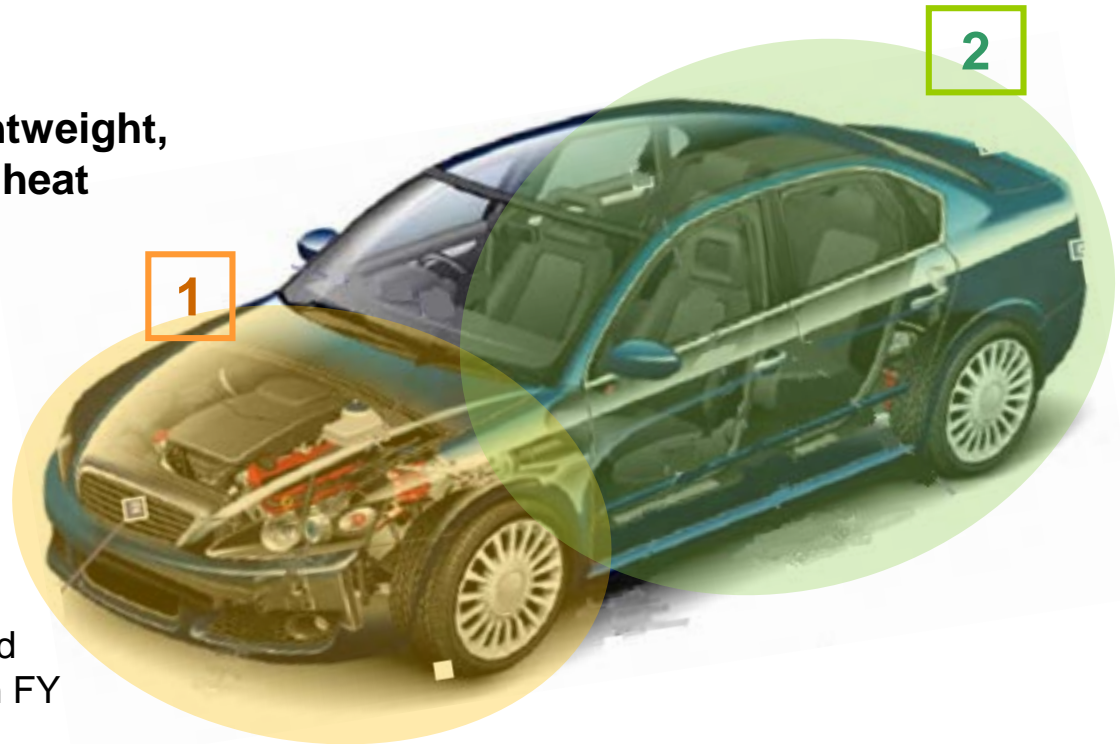

- Presentation and proposals to Japanese and European OEMs and suppliers beginning in FY 2019.
- Bench-scale sample provision scheduled from Q4 FY 2019.

3. New business development

Characteristics of foamed polyamide

High heat resistance
Melting point: up to 200°C

Solvent resistance, high modulus

Unique polyamide foaming beads

Lightweight
(5x foaming ratio)

Noise absorption

- Technology to form continuous voids
- Technology to design sound absorbing/isolation parts

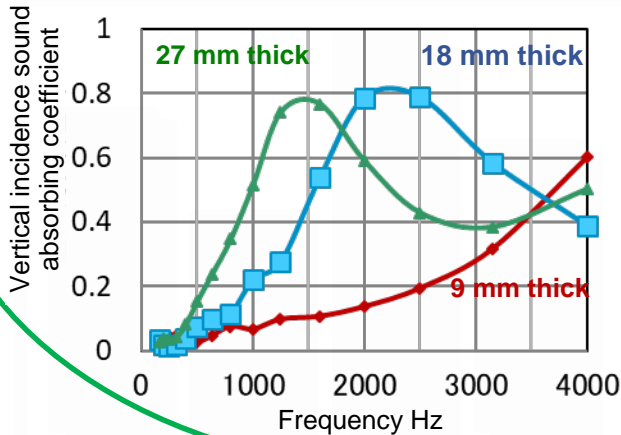

- Flexibility of molding with foamed beads

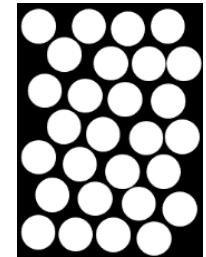
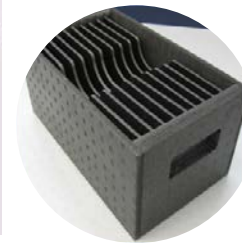

- Closed-cell foam with high rigidity and heat insulation

Special molding technology that enables molding foamed polyamide

Moldability

3. New business development

Cellulose nanofiber composite material

Environmental material under development for vehicle lightweighting

Features of cellulose nanofiber (CNF)/polyamide composite material

- ✓ Low environmental load (CNF is natural material and carbon neutral)
- ✓ Light weight and excellent shape retention

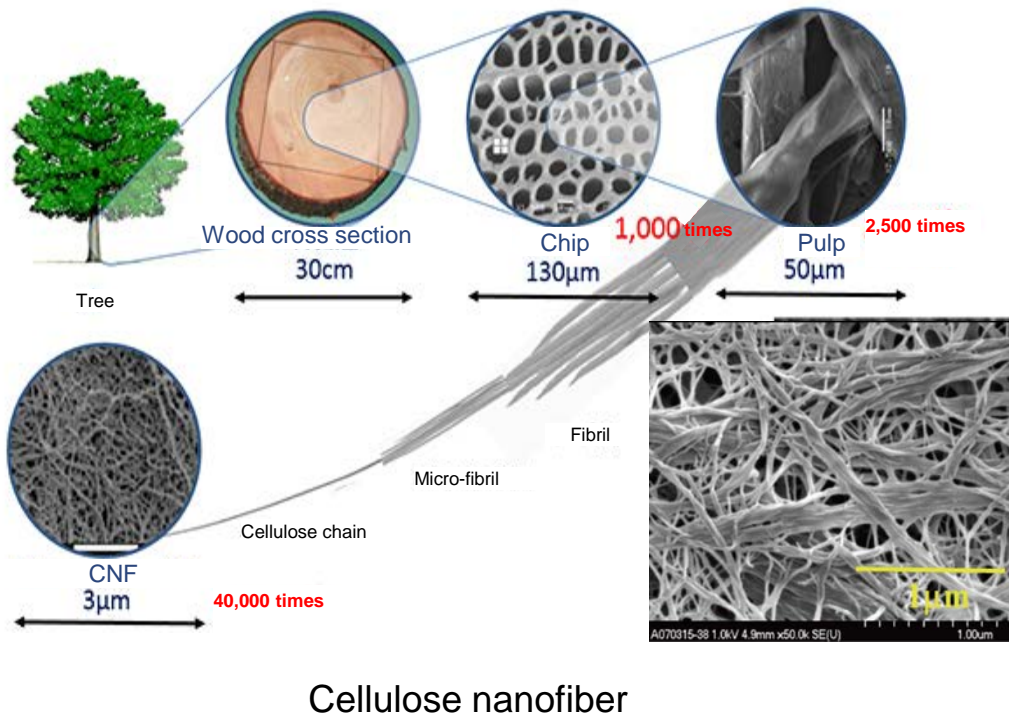

Enables lightweighting with shape retention equivalent to aluminum

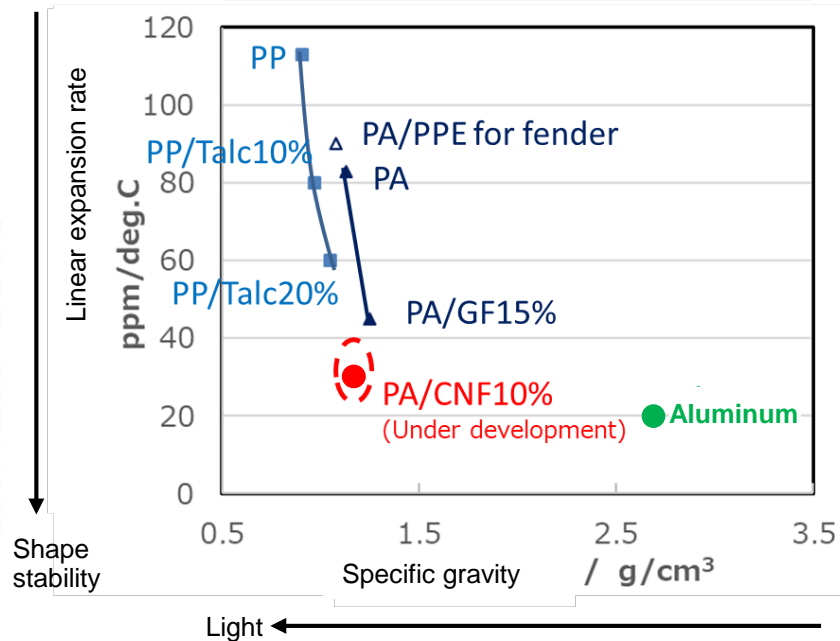

4. Strategy through acquisition of Sage

Basic strategy through acquisition of Sage

- ✓ Utilize **connections with automobile manufacturers against background of high product quality and design capability** of Sage
- ✓ Reinforce global cooperation with automobile manufacturers through enhancement of **product variation × production in optimal locations**
- ✓ **Create new value and pursue synergy with other automotive-related businesses** for the development of next generation vehicle interiors

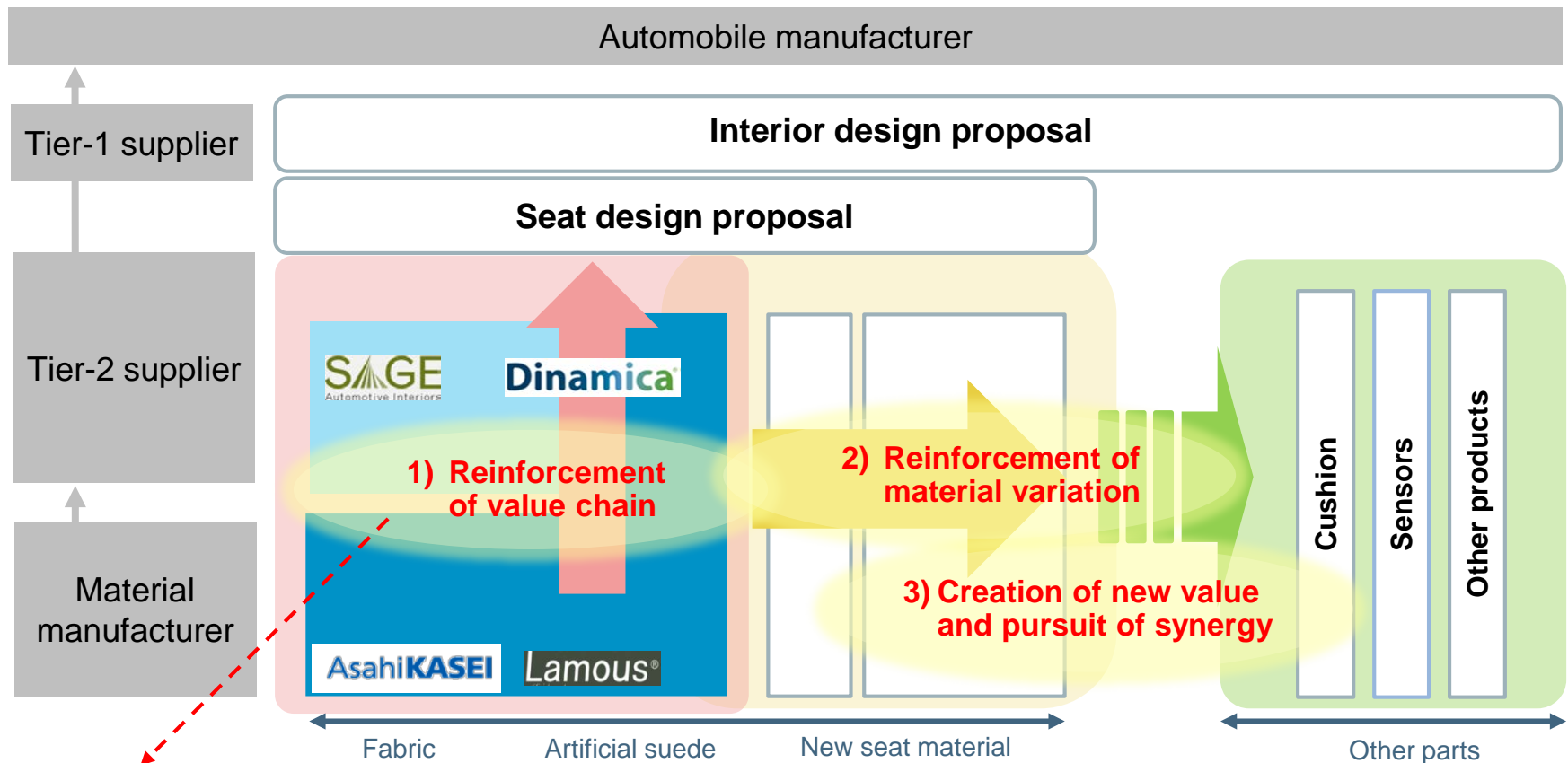

1) Sales network and applications of existing products expanding remarkably, centered on artificial suede

Progress of synergy between Asahi Kasei and Sage

- ✓ Expanding business and reinforcing connections with automakers by strengthening the value chain
- ✓ Aiming to be the Global No. 1 vehicle interior material manufacturer in the medium term, by leveraging Asahi Kasei's development resources with Sage's platform and advancing developments toward CASE

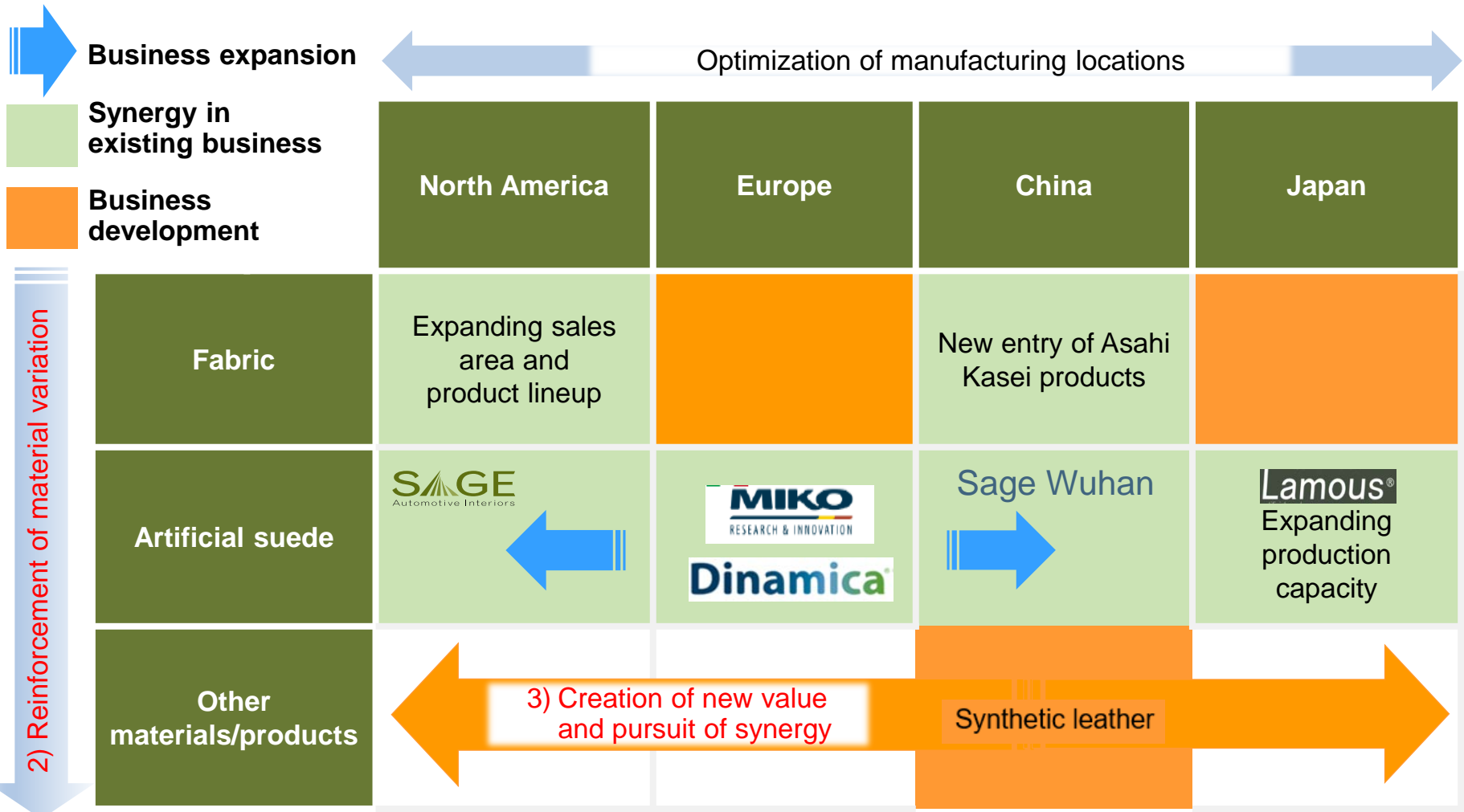

Accelerating further growth

✓ Collaboration with Sage for innovation in mobility for society and the growth of the Asahi Kasei Group

**Sales target in Mobility field
(overall)**

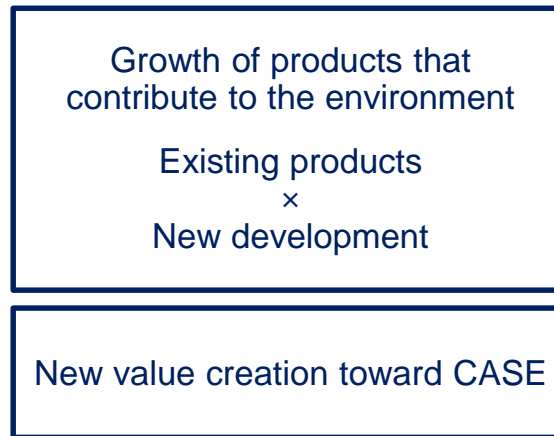
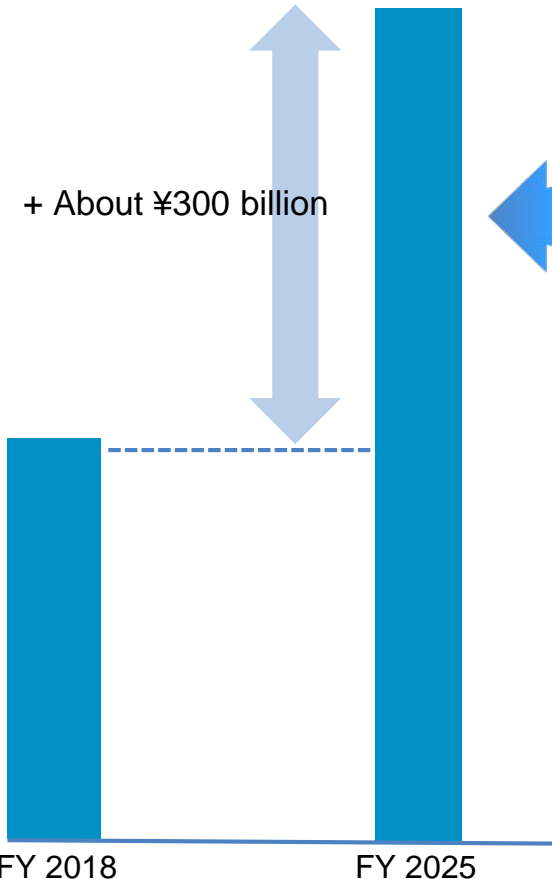

Synergy with Sage

Consistent execution of plans

Sales of Sage targeted at over ¥100 billion



Blank for your note



Care for People Care for Earth

Hideyuki Yamagishi
Senior Executive Officer
President, Specialty Solutions SBU

AsahiKASEI

November 14, 2019

Blank for your note

Outline

1. Mission and strategy outline of Specialty Solutions SBU
2. Main products
3. Growth strategy of LIB separator business

1. Mission and strategy outline of Specialty Solutions SBU







Mission

Contribute to earnings of the Asahi Kasei Group by strengthening the initiative to provide new value to the market, through enhancement of high performance materials and promotion of solution businesses

Strategy outline

1. Advance focus and differentiation; further evolve high-earnings businesses (No. 1, niche top, one-of-a-kind) through continuous transformation of the business portfolio and concentration of resources on main products
2. Create unique solution-oriented businesses focused on customer value

2. Main products

Product	Main applications	Asahi Kasei's position
Hipore, Celgard (LIB separator), Daramic (Lead-acid battery separator) 	Separators for LIB, lead-acid battery	No. 1 world share
Aciplex ion-exchange membranes, membrane-process electrolyzers 	Chlor-alkali electrolysis	Membranes: No. 1 world share Electrolyzers: No. 2 world share
Glass fabric 	Electrical insulation for printed circuit boards in portable devices such as smartphones and equipment for telecommunications infrastructure	Top-tier world share in super thin fabric and low dielectric fabric
Sunfort dry film photoresist 	Forming copper circuit patterns on printed wiring boards and semiconductor packaging	World top-3 share: 30%
Ceolus microcrystalline cellulose 	Additives for pharmaceuticals and foods	No. 1 domestic share
Duranate HDI-based polyisocyanate 	Non-yellowing polyurethane curing (coatings, inks, adhesives, cast molding, etc.)	World top-3 share No. 1 domestic share
APR and AFP photopolymers and platemaking systems 	Printing plates for packaging such as cardboard, labels, and film	No. 1 domestic share

3. Growth strategy of LIB separator business

LIB separator

Used in lithium-ion batteries (LIBs) for automobiles, consumer electronics, and energy storage systems (ESS); an important product that supports the world's infrastructure



Consumer electronics application



ICT*, power tools and gardening tools

- Cordless electric tools
- Horticultural machines
- Tablets
- Smartphones

* Information and communications technology

Automotive application



Electric vehicles (xEV)

- Battery electric vehicle (BEV)
- Plug-in hybrid vehicle (PHEV)
- Hybrid electric vehicle (HEV)

ESS application



- Distributed storage
- Integration with renewable energy
- Load leveling

Outlook of Asahi Kasei's LIB separator business

**Top supplier of LIB separators;
contributing to maximized value based on firm relationships with customers**

LIB separator market

Global shipments:
3,282 million m²
+20.4% (year-on-year)

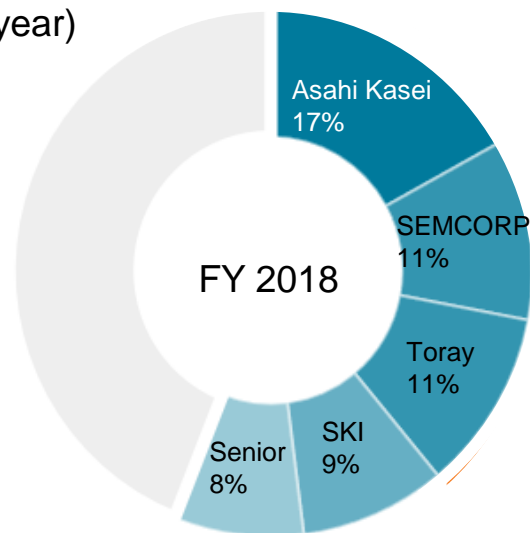

Source: Nikkei Inc., Nikkei Visual Data (7/8/2019)

LIB separator market trend

Growth in all three market segments of automotive, consumer electronics, and ESS

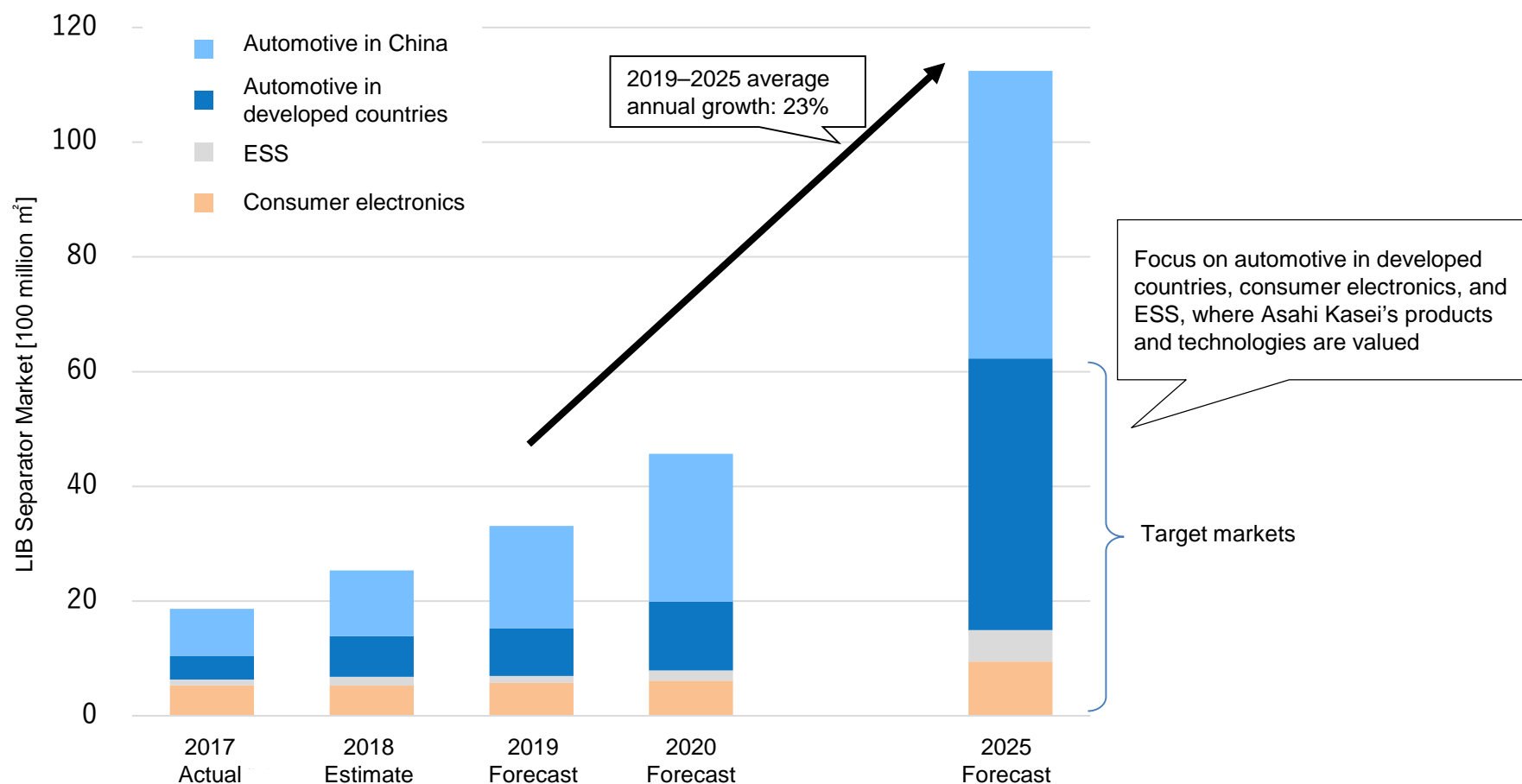

Source: Calculated by Asahi Kasei based on "Future Outlook of Energy, Large Scale Secondary Battery, and Materials 2018; Energy Device Edition" and "Future Outlook of Energy, Large Scale Secondary Battery, and Materials 2019; Next Generation Environmental Automotive Field Edition" by Fuji Keizai Co., Ltd.

Future outlook of automotive market

BEV, PHEV, and HEV will all increase

xEV market forecast by vehicle units

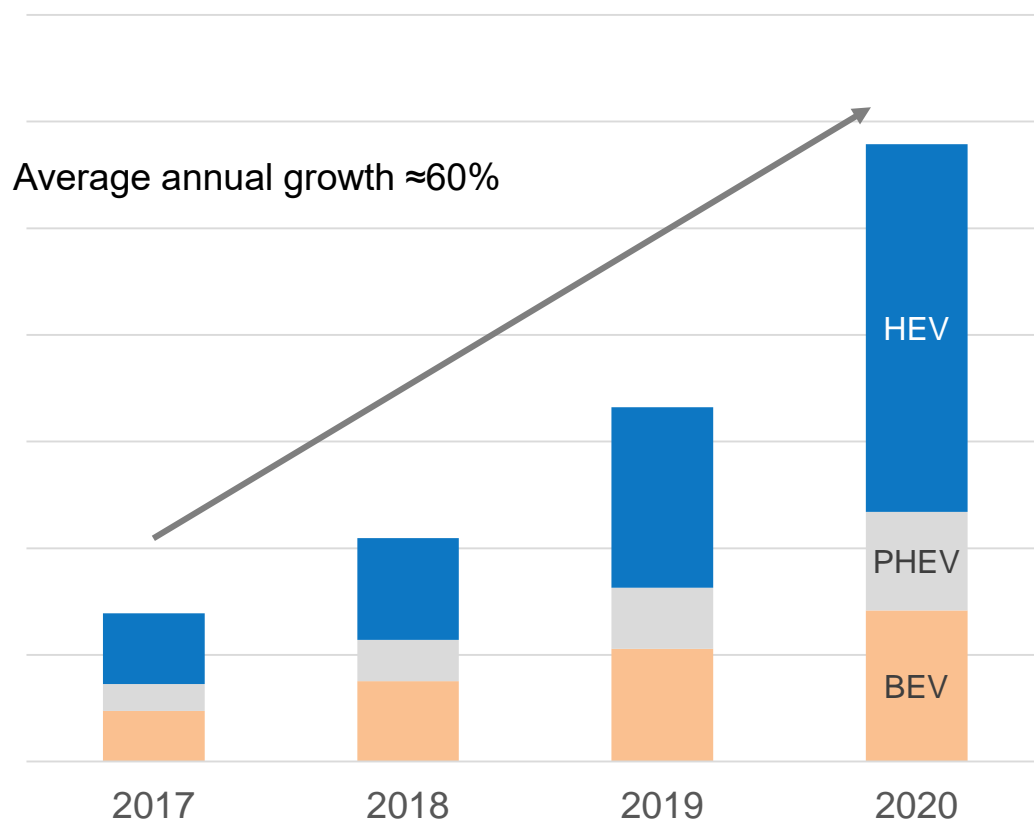

Features required for LIB

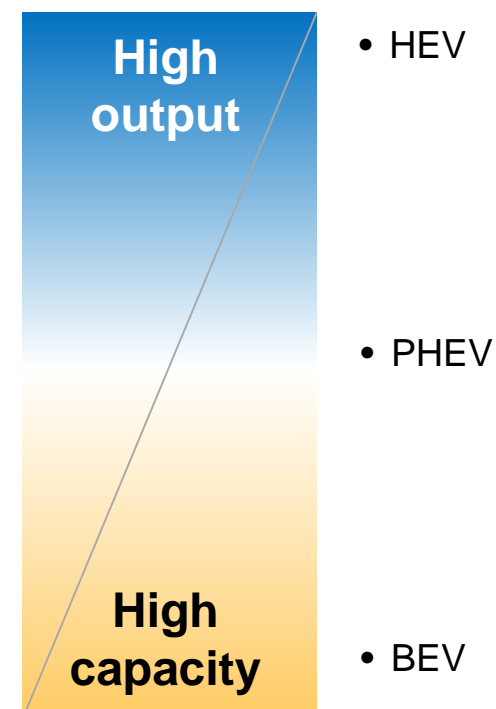

Source: Estimate by Asahi Kasei

Advantage and strength of Asahi Kasei's LIB separator

Meeting the needs of a wide range of markets and customers with two different product lines/manufacturing processes

Battery features	Main applications	Product	Advantage and strength
High capacity × Safety	Consumer electronics Smartphones, power tools, etc. Automotive BEV, PHEV	Hipore wet process	<ul style="list-style-type: none"> • Product development from the stage of in-house raw material ⇒ High strength, thin film • Cutting-edge production technology and strict quality control ⇒ Stable high quality • Accumulated know-how on material and manufacturing ⇒ Customized film design according to customer requirements, stable mass production
High output × Durability	Automotive HEV ESS	Celgard dry process	<ul style="list-style-type: none"> • Rectilinear pores in thickness direction ⇒ High Li-ion permeability • Zero heat shrinkage in transverse direction ⇒ Usable without coating • Trilayer structure of PP/PE/PP ⇒ Excellent oxidation resistance

- **Environment-friendly manufacturing processes**

Hipore: Significantly reduced emissions of solvent into the air

Celgard: Manufacturing process without using solvent

- Comprehensive **patent network** established through long-term business experience

Capacity expansions for Asahi Kasei's LIB separator

Capacity expansions for LIB separator to prepare for upcoming market growth

Asahi Kasei production capacity for LIB separator

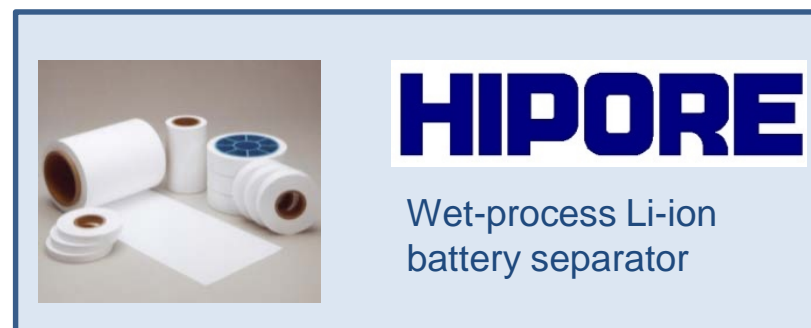
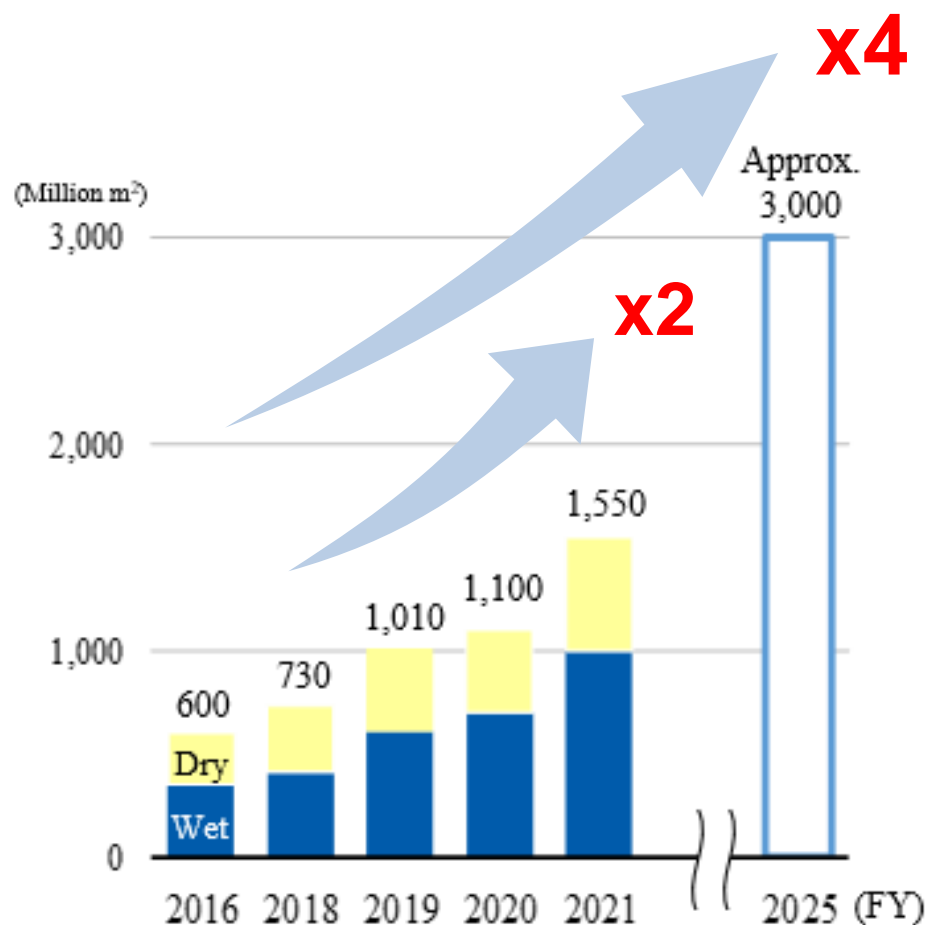



Care for People Care for Earth

Yoshihiro Ono
Senior Executive Officer
President, Basic Materials SBU

AsahiKASEI

November 14, 2019

Blank for your note

Mission of Basic Materials SBU

1. Establishment and reinforcement of stable earnings foundation
2. Stable supply of raw materials and utilities to businesses within the Asahi Kasei Group and implementation of energy policy with due consideration for ESG
3. Development and promotion of chemical technologies that contribute to sustainability

Main products

	Asahi Kasei Capacity (kt/y)	Main competitors	Main applications	Asahi Kasei's position/strengths
Acrylonitrile	981	Ineos Nitriles, Ascend	ABS, acrylic fiber, carbon fiber; captive use for SAN, adiponitrile	Plants in Japan, Korea, and Thailand; world's 2nd largest producer
Styrene	390	Lyondell Basell, Ineos Styrolution, Shell	PS, EPS, ABS, SB latex, unsaturated polyester, SBR; captive use for PS, SAN, SB latex, SBR	After 320 kt/y plant in Mizushima closed in Feb. 2016, business focused on domestic market and captive use
Methyl methacrylate	170	Mitsubishi Chemical, Sumitomo Chemical	MS, MBS, coating materials, cast sheets; captive use for PMMA	Proprietary, cost-competitive C4 process
Cyclohexanol	180	Shandong Haili, BASF	Adipic acid; captive use for adipic acid	Proprietary, economically-competitive, environmentally-friendly process with low waste; mainly for captive use
Polyethylene	236	(Domestic) Japan Polyethylene, Prime Polymer	Films, miscellaneous goods, food containers, injection molding; captive use for LIB separator	Business development taking advantage of unique characteristics based on distinctive catalyst technology, including high density polyethylene
Polystyrene	315	(Domestic) Toyo Styrene, DIC	Food containers, food packaging, toys, miscellaneous goods, construction materials	Production and sale by PS Japan; largest producer in Japan

Asahi Kasei's CO₂ chemistry

Developing CO₂ chemistry, which utilizes CO₂ as chemical feedstock, since the 1980s

EC process for polycarbonate production



DRC process for DPC for polycarbonate production

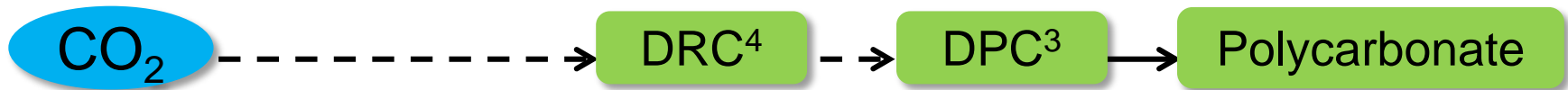

CO₂-based isocyanate production process



———> Commercialized - - -> Validated > Under development

Continuing to develop chemical technology that contributes to sustainability

Basic policy of acrylonitrile (AN) business

1. Continuing contribution to customers' business

- ✓ World's No. 2 and Asia's No. 1 production capacity
- ✓ World's top-class stable operation and stable supply

➔ Continuing to be the supplier providing **the world's No. 1 reliability** to customers

2. Further evolution of top-level catalyst technology and manufacturing process

- ✓ Propylene process with catalyst with the world's No.1 yield and the world's first propane process
- ✓ Manufacturing process requiring less raw materials and reducing CO₂ emissions by 20%

➔ Contributing to **sustainability** through superior technology

3. Stabilization of earnings

- ✓ Promoting cost-based formula for AN sales price
- ✓ Developing by-product and derivative businesses

➔ Reinforcing role as **base of stable earnings for the Asahi Kasei Group** by reducing risk from market price volatility



Implementation of energy policy with due consideration for ESG

Renovation of hydroelectric power plants to increase clean energy supply

- Since the company's founding, Asahi Kasei has had hydroelectric power plants in northern Miyazaki Prefecture to supply electric power to manufacturing plants in Nobeoka
- Sequentially renovating the 9 hydroelectric plants by FY 2026, with total investment of tens of billions of yen; increasing hydropower capacity to reduce the use of power from coal, lowering CO₂ emissions
- Studying issuance of the company's first "green bond"



Gokasegawa power plant



Mamihara power plant

(Asahi Kasei has 9 hydroelectric power plants in Miyazaki and Kumamoto Prefectures)

Blank for your note



Care for People Care for Earth

Eiji Honda
President, Asahi Kasei Microdevices Corporation

AsahiKASEI

November 14, 2019

Blank for your note

Outline

1. Core technologies and main products
2. Business domain expansion
3. Role of Asahi Kasei Microdevices
(contribution to the Asahi Kasei Group)
4. Examples of product development contributing to environment and energy

1. Core technologies and main products

Core technologies

Analog/digital signal conversion technology (**LSIs**); sensing technology using **compound semiconductors** for high sensitivity and fast response

For consumer electronics

Identifying direction you are facing on the map

Electronic compass

Optical autofocus/image stabilization for higher-quality pictures

High-precision position control IC for camera module

Higher-quality sound with smartphones

Signal processing IC for audio equipment

For automotive

Quieter and more comfortable space

Signal processing IC for noise and echo cancellation

Power window anti-pinch function, windshield wiper control, etc.

Motor control sensor

Millimeter wave radar

Signal processing IC

Monitoring EV charge

Current sensor

For industrial equipment

Precision control of robots

Magnetic rotational angle sensor

For residential

Detecting presence of people

Infrared sensor



2. Business domain expansion

Expanding into new business domains peripheral to current domain

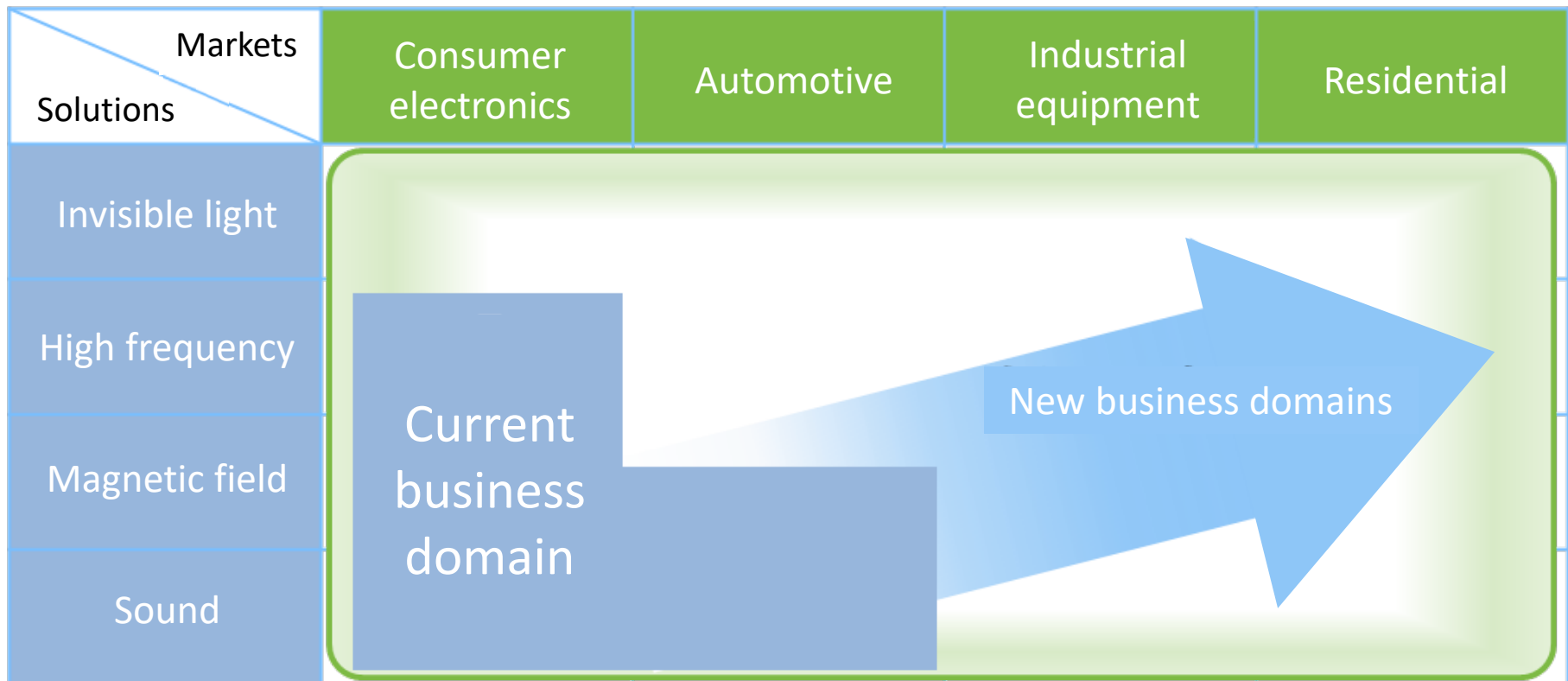

3. Role of Asahi Kasei Microdevices (contribution to the Asahi Kasei Group)

▶ **Efficient collection of latest information on leading markets** centered on electronics

▶ **Conversion of collected information into value for the Asahi Kasei Group**

▶ **Contributing to earnings through provision of total solutions**



4. Examples of product development contributing to environment and energy (i)



Compound semiconductors

- Technologies** Design and manufacture of compound semiconductor devices
- Products** Infrared sensor, infrared LED
- Strategy** Application to gas sensor products

Main applications for CO₂ sensor



Present:
Air conditioning control for buildings, environmental monitoring for housing

➔



Future:
Vehicle interiors

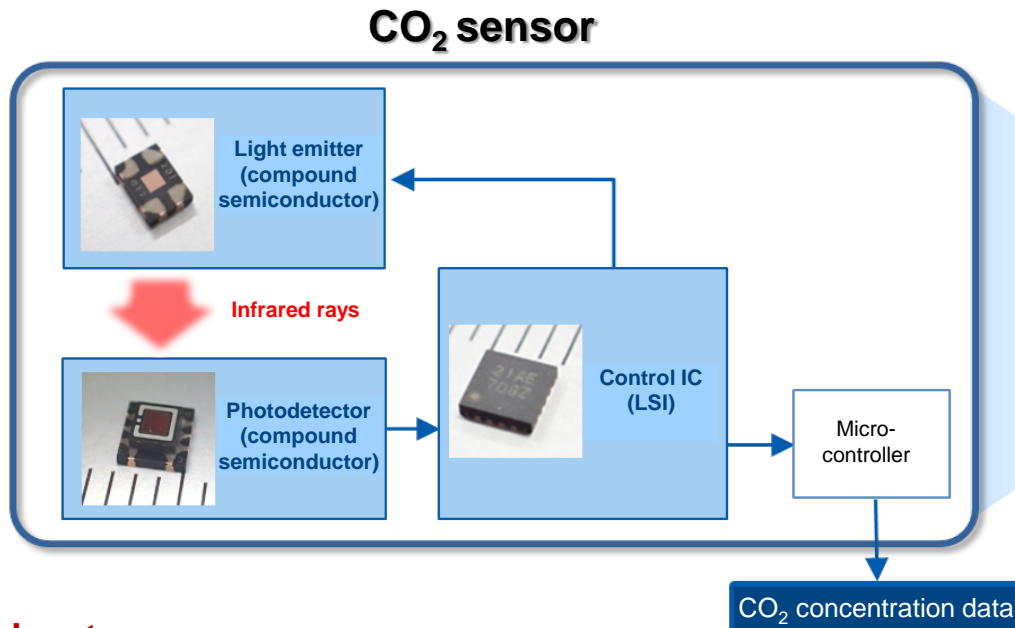

CO₂ sensor module



As small as an eraser



HVAC* systems that ventilate based on CO₂ concentration ➔ **Energy saving**

Advantage

Achieve **high sensitivity CO₂ sensor** by combining core technologies of LSIs and compound semiconductors with newly introduced module technology

* Heating, ventilation, and air conditioning

4. Examples of product development contributing to environment and energy (ii)



LSIs

Technologies	Ultralow power consumption and signal conversion
Products	Voltage conversion IC, power management IC
Strategy	Application to power LSI for energy harvesting

Advantage

Achieve **energy harvesting system** by enabling minute drive voltage (0.2 V) and system operation control with ultralow power consumption

Example of environmental sensing using microbiological electric generation

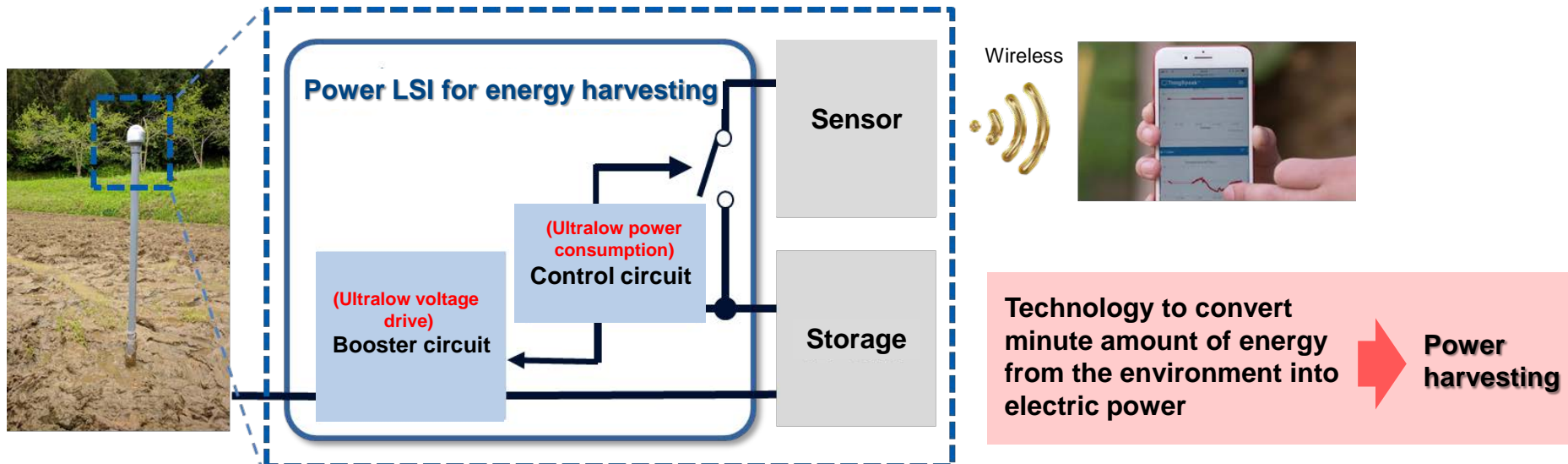

Creating for Tomorrow

The commitment of the Asahi Kasei Group:

To do all that we can in every era to help the people of the world make the most of life and attain fulfillment in living.

Since our founding, we have always been deeply committed to contributing to the development of society, boldly anticipating the emergence of new needs.

This is what we mean by “Creating for Tomorrow.”

AsahiKASEI